

## Wi-Fi controller installation manual

To be installed with:

**SANDEN ECO<sup>®</sup> PLUS System with Natural Refrigerant (CO<sub>2</sub>)**

**Heatpump Unit: GAU-A45HPD**

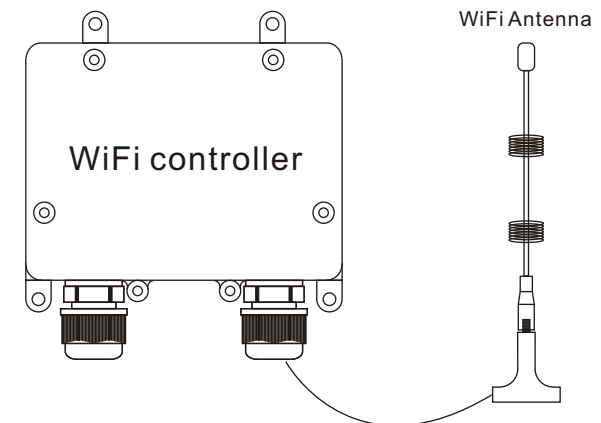

**PATENT PENDING**

**This Sanden Wi-Fi Controller is the subject of an Australian Patent in the name of Sanden Australia Pty Ltd**

**TRADEMARKS**

**® Registered trademark of Sanden Australia Pty Ltd.**

### **Sanden International (Australia) PTY LTD**

Unit 6, 17 Willfox Street, Condell Park, NSW, 2200 Australia  
Ph: +61 29791-0999 Email: [sales@sanden.com.au](mailto:sales@sanden.com.au)  
Web: [www.sanden-hot-water.com.au](http://www.sanden-hot-water.com.au)

**Note: Every care has been taken to ensure accuracy in preparation of this publication. No liability can be accepted for any consequences that may arise as a result of its application. Sanden is in a process of continuous improvement; therefore specifications may be different to those referenced in this manual. Please contact Sanden International or its distributors for the latest specifications at the time of installation.**

# Contents

---

- Introduction* ..... 1
- How it works* ..... 2
- Installation* ..... 3
- Electrical and data connections* ..... 3
- Hardware configuration* ..... 4
- Software configuration* ..... 5
- Controller functions* ..... 6
- Home page* ..... 6
- Block out Timer* ..... 6
- Instant Boost*..... 6
- Power Consumption* ..... 6
- Setting additional heating times* ..... 7
- Troubleshooting* ..... 7
- Technical Data*..... 8
- Warranty* ..... 9

# Warranty Policy

---

## Warranty Period

Subject to the Warranty Conditions and Exclusions stated above, your Sanden Wi-Fi Controller is warranted in a Residential application for 1 year, parts and labour, from date of installation.

**Warranty terms and conditions are subject to change without notice. Please refer to our website [www.sanden-hot-water.com.au](http://www.sanden-hot-water.com.au) for the latest updated Warranty information.**

**Product and Warranty Registration:  
Please refer to our website [www.sanden-hot-water.com.au](http://www.sanden-hot-water.com.au)**

## Warranty Policy

---

### Warranty Conditions

1. The Sanden Wi-Fi-controller must be installed in accordance with the installation instructions supplied with the Wi-Fi-controller and in accordance with all relevant statutory and local requirements of the state in which the Wi-Fi-controller is installed.
2. Where a failed component or Wi-Fi-controller is replaced under warranty, the balance of the original warranty period will remain effective. The replaced part or Wi-Fi-controller does not carry a new warranty.
3. Where the Wi-Fi-controller is installed outside the boundaries of a metropolitan area as defined by Sanden or further than 25 kilometres from an accredited service agent, the cost of transport, insurance and travelling costs between the nearest accredited service agent's premises and the installed site shall be the owner's responsibility.
4. Where the Wi-Fi-controller is installed in a position that does not allow safe, ready access, the cost of accessing the site safely, including the cost of additional materials handling and/or safety equipment, shall be the owner's responsibility.

### Warranty Exclusions

This warranty covers the controller hardware, exclusively. Repair and replacement work will be carried out as set out in the Sanden Heat Pump Water Heater System warranty . However, the following exclusions may void the warranty and may incur a service charge and/or cost of parts:

1. Connection issues with owner's Wi-Fi modem and service provider
2. SmartLife app related issues and functionality
3. Accidental damage to the Wi-Fi-controller or any component, including: Acts of God , failure due to misuse, incorrect installation, attempts to repair the Wi -Fi -controller other than by a Sanden accredited service agent or the Sanden service department.
4. Where it is found there is nothing wrong with the Wi-Fi-controller; or where there is a failure of electricity or where the supply of electricity does not comply with relevant codes or acts.
5. Warranty service is provided to the original owner of the equipment only.

## Overview

---

### Introduction

The Wi-Fi Controller has been designed to provide remote access to the Sanden GAU-A45HPD heat pump via a smartphone or tablet.

Available information includes Current heat pump status, Local Time and Power consumption.

Functions include Remote one touch boost, multiple timer programming and error reporting.

In addition, remote access by installers enables health checks and fault finding.

### How it works

- The external Wi-Fi controller is hard wired to the internal Modbus interface included in the GAU-A45HPD (not available in earlier models) and then connects to a 2.4Ghz powered Wi-Fi of choice.
- Access is provided via the SmarLife app which is downloaded onto a smartphone or tablet.

## Installation

**NB: Ensure that Power Isolation switch is in the “OFF” Position / power is not supplied to the heat pump. Electrical installation should only be done by a licensed electrician who carries out the work according to the relevant regulations for electrical safety and wiring.**

### 1: Electrical and data connections:

**Remove the Access panel on RHS of the heat pump**

**Connect the 2-core power connector to the same connection points as the “power” connector as below.**

**Connect the 4-core data cable to the internal modbus connector as below.**

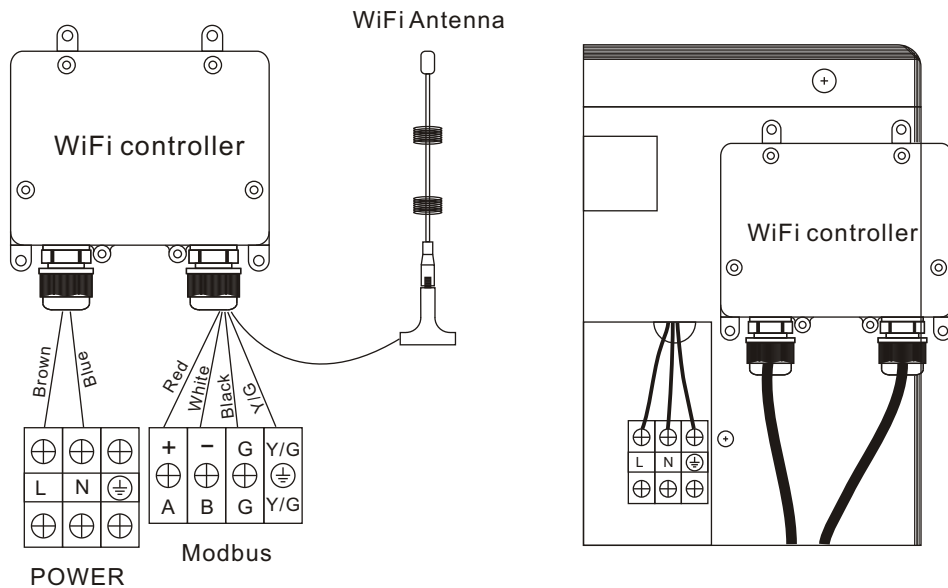

*Note: Controller must be mounted vertically with cable access facing down. Ideal location is at rear top on right hand side of the heatpump (fixing tape) however 2m cables make remote mount also possible (screws provided). Wi-Fi antenna must be installed outside of heat pump. It has a magnetic base so can be mounted on the lid of the heat pump or any surface without frequency interference.*

## Operation

### Controller LED operation:

LED	Description
Red Led	ON: Power normal OFF: No power
Blue Led	ON: Modbus communication normal OFF: Modbus error
RGB Led	Red: WiFi not connected Green: WiFi connected and access to internet Blue: WiFi connected but no internet Yellow: Updating firmware Purple: WiFi connect failure, must reset WiFi

### Technical Data

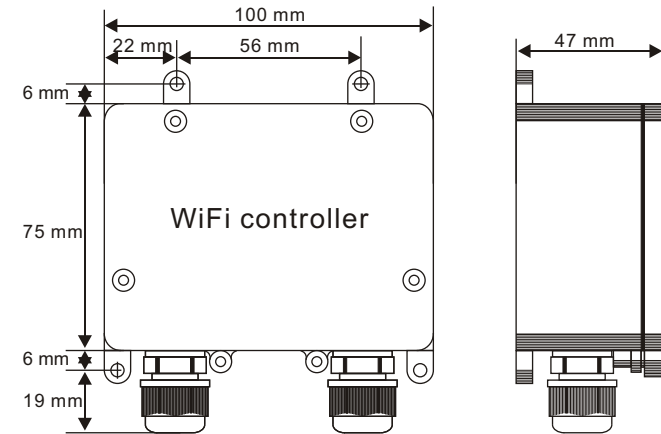

WiFi Controller is waterproof and UV rated for outdoor installation.

2-meter cables with disconnection points offer installation point flexibility

Antenna with magnetic base to be installed externally to the heat pump in a position with no transmission interference.

2.4GHz WIFI home router required to connect.

Electrical connection: 240V AC

## Operation

### Setting additional heating times:

Navigate to the “Smart Home” home page and tap the “Scene” button on navigation bar.

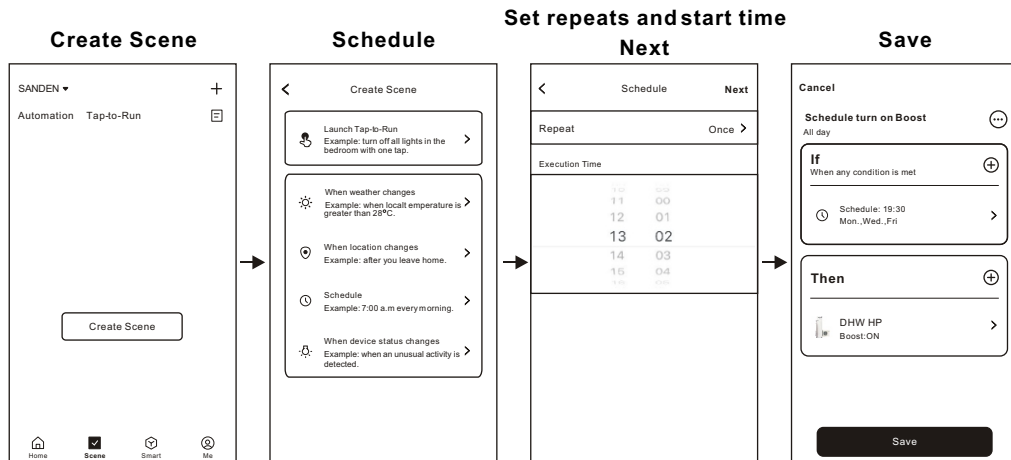

### Troubleshooting:

#### Reset WiFi

If you change the WiFi's SSID or password, you have to reset the WiFi module and connect to it again.

First, open the WiFi controller cover, then find “SW1” and change the 4<sup>th</sup> switch position

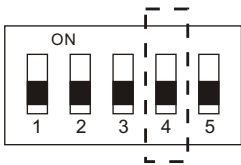

SW1	Function	Operation
4	Reset WiFi	Change the switch to opposite position

Close cover, allow the controller to reconnect.

## Installation

### 2: Hardware Configuration:

Remove top cover of heat pump.

Lift out internal controller.

Press Enter key once if controller is in Standby mode. Hold down Up and Down keys together in the clock display mode to access maintenance mode.

Use Up or Down key to go to Communication setting mode. [C\_SE], press Enter.

#### Communication setting mode

This mode is used to set the Modbus connection.

NB: This mode is used only for connection to an external Wi-Fi controller.

Change the mode operation:

Press the Up or Down key to change the setting. Please select: [onHP] mode

Select when Modbus controller is connected.

In this mode, heat pump will NOT operate without instruction from Modbus controller.

Confirmation of Modbus connection setting Press Enter key to confirm the setting.

#### Go back to clock display mode

Hold down Enter key to go back to the clock display mode. It will automatically go back to the clock display mode when no panel operation is performed for more than 60 seconds.

# Installation

## 3. Software Configuration

### 3.1 Download the APP

Download the **Smart Life** APP from Apple store or Google store.  
Or scan the QR code.



### 3.2 WiFi connection

Open APP, click “+” on top right corner, then select “Add Device”, the APP will discover the device automatically, named “DHW HP” .

*Note: Please turn on Bluetooth and allow Bluetooth permission of the smartphone.*

## 4. Complete system information

Tap on the Heat Pump icon to access the home page

Tap setting icon, then initial setting



# Operation

## 5. Controller functions

### Home page

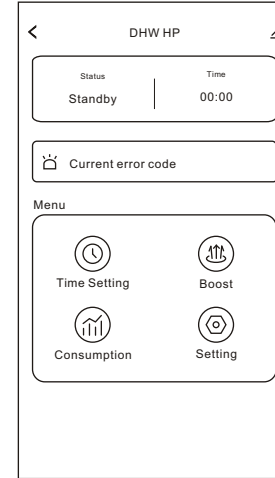

Status:  
Standby  
Heating  
Air purging  
Freeze protection

Time  
Current time of  
heat pump

Error Code  
-- = none

### Block out timer

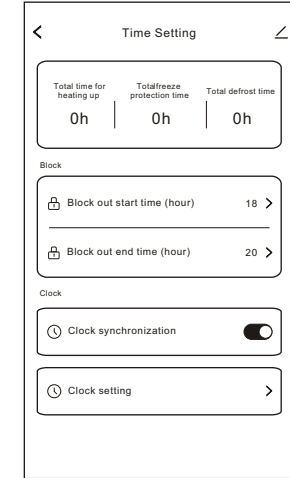

Total heating,  
Anti-freeze and  
Frost protection  
Run times

### Instant Boost

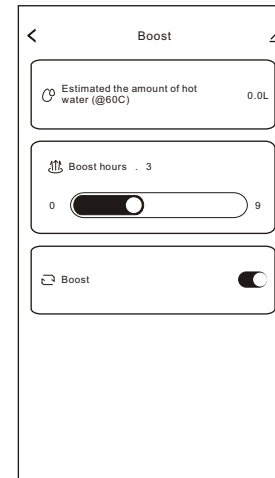

Select number of boost hours.  
Unit enters Standby mode after  
selected time/ tank is heated.

Select to activate boost.

### Electricity Consumption

