



SANDEN

Delivering Excellence

Ecoi
Eco system of Sanden

Owner's manual

Sanden Heat Pump Water Heater with Natural Refrigerant (CO₂)

Covering model numbers for residence

GAUS-160FQS

GAUS-250FQS

GAUS-300FQS

GAUS-315FQS

GAUS-315FQV

Heat Pump Unit GAU-A45HPC



This appliance is not to be used by persons (including children) with reduced physical, sensory or mental capabilities, or lack of experience and knowledge, unless they have been given supervision or instruction.

Children being supervised not to play with the appliance.

Contents

Page title.....	1
Contents	2
Introduction	3
How it works	3
Installation details	8
Trouble Shooting Guide.....	9
Error Codes	10
Removing air from the system	11
Electrical connections	12
System operation, if connected to continuous power.....	12
System operation if connected to off-peak electricity.....	12
How to connect power line and thermistor cable	13
Water Supply Quality	14
Change of water supply	14
Technical data	15
Warranty Policy.....	18
Warranty Period.....	19
Registration for warranty.....	19

PATENTS

This water heater may be protected by one or more patents or registered designs in the name of Sanden Australia Pty Ltd

TRADE MARKS

® Registered trademark of Sanden Australia Pty Ltd

Note: Every care has been taken to ensure accuracy in preparation of this publication.

No liability can be accepted for any consequences that may arise as a result of its application. No liability can be accepted for any consequences that may arise as a result of its application. Sanden is in a process of continuous improvement, therefore specifications may be different to those referenced in this manual – Please contact Sanden International or its distributors for the latest specifications at the time of installation.

Introduction

The Sanden Heat Pump Water Heater System has been designed using the latest refrigeration technology to remove the heat from the air to heat water. The refrigerant we use is CO₂ which does not contribute to global warming so it allows us to help keep a clean healthy earth for future generations.

We have also considered the power requirement. By using CO₂ as the refrigerant we have produced one of the most energy efficient units currently available. It's even more efficient when connected to off-peak power and the noise level is so low it will operate unobtrusively throughout the night.

How it works

The Heat Pump Water Heater System heats water by transferring the heat from the surrounding air to the water using a refrigerant. The refrigerant is heated by a heat exchanger that absorbs heat from the surrounding air (Figure 1).

Figure 1: Heat Pump Water Heater System

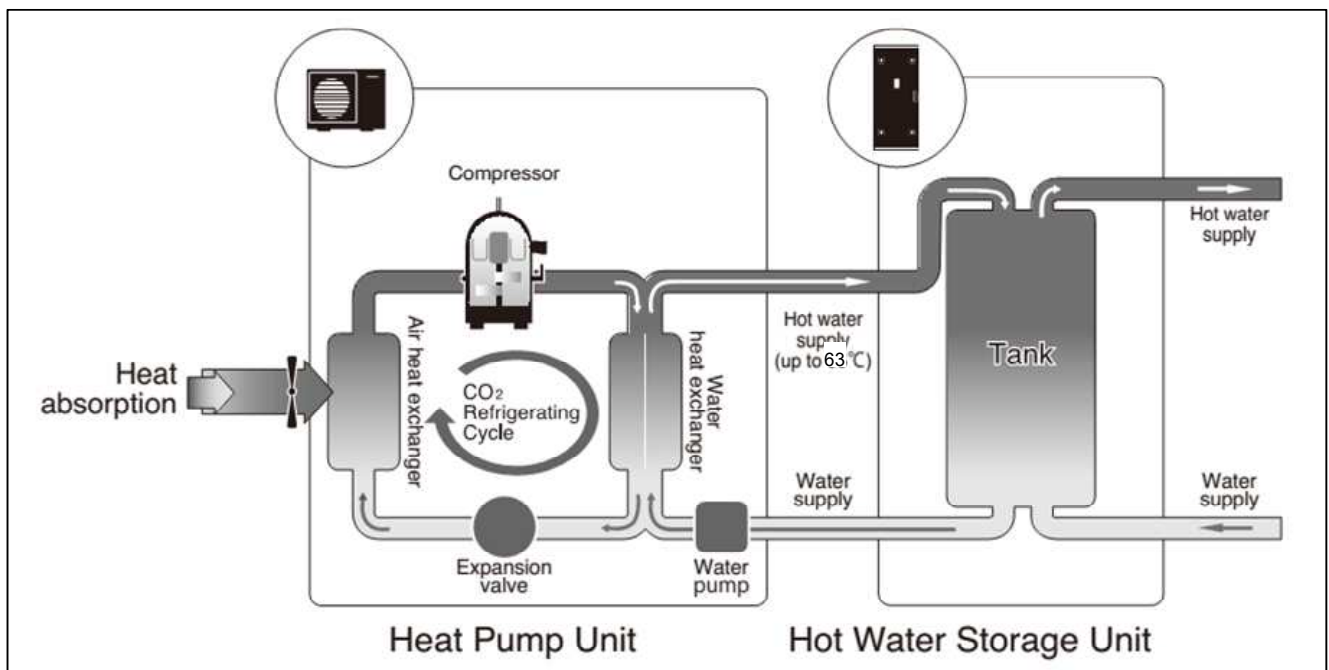



Note: Operating conditions may vary depending on the type of off-peak tariff that is available in your area. The unit must have a minimum of 5 hours continuous power available at all time to allow the unit to operate without affecting reliability.

Safety precautions







Please ensure you fully observe the precautions.

The following instructions need to be fully followed to prevent any harm to users and others or damage to your property.

■ The extent of the possible harm or damage caused by misuse of the product falls into the following classifications.



 Warning	The column with this classification indicates “the extent of harm that includes the possibility of death or serious injury”.
 Caution	The column with this classification indicates “the extent of harm/damage that includes the possibility of injury or damage to property”.

■ The type of content to be observed can be explained with the following pictorial classifications.

	Indicates content requiring “attention”.
  	Indicates content that is prohibited.
 	Indicates content with “instructions” that need to be fully followed.

Warning

Do not touch the tap while hot water is being supplied

Do not touch

Could result in being burnt by hot water.

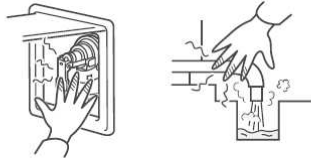

Do not touch the relief valve, drainage pipe, drain outlet or drain elbow when inspecting the relief valve or while draining hot water.

Do not touch

Could result in being burnt by hot water.

Check the water temperature before supplying any hot water or taking a shower.

Could result in being burnt.

Do not touch the heat pump unit pipes or hot-water supply pipes.

Could result in being burnt.

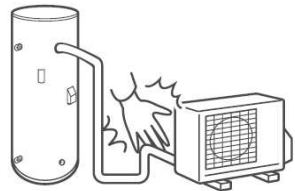
Warning

Do not use any damaged, altered, or bundled power cords.

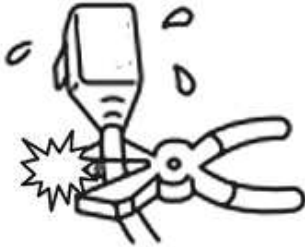

Verify that the piping has all been insulated.

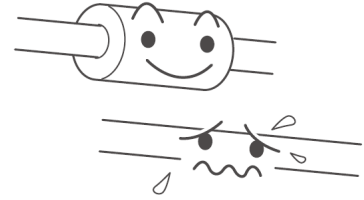

Any of the pipes freezing up and getting damaged could result in scalding or water leaking.

- Please contact the Dealer about insulating the pipes.

Ensure the product is removed from any gas containers, sources of fire and flammable substances.

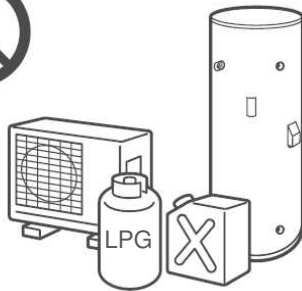

Sparks from the electrical parts of the product could result in fire.

Do not disassemble, repair or alter the product in any way.



Do not disassemble

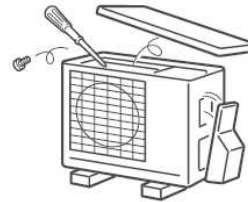

Could result in electric shock or fire.

- Contact the Dealer for repair.

Do not open the front board of the hot water storage unit or the heat pump unit cover.



Do not disassemble

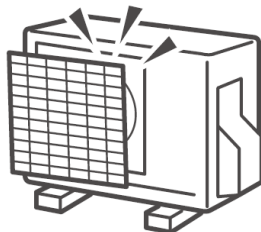

Could result in electric shock.

Do not poke your fingers or a stick into the air inlet (fins)/air outlet of the heat pump unit.



Attention – Rotating object

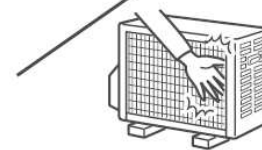
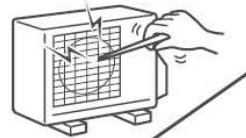

Could result in injury.

⚠ Caution

Do not climb or put anything on top of the unit. Do not apply any force to the piping.

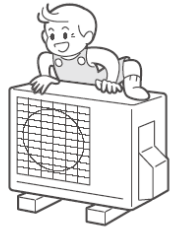

Could result in injuries from a fall or being scalded.

Do not use the heat pump unit if the installation blocks have been damaged.

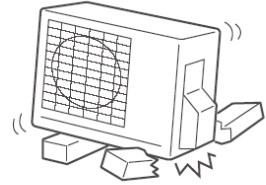

Damaged installation blocks could result in the heat pump unit falling over and causing injury.

Do not put anything susceptible to humidity under the heat pump unit.

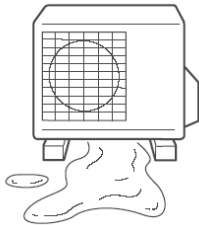

Water could drain out. In addition, condensation could drip from the pipe connections.

Ensure no animal or plant life is placed directly in front of where air is blown from the unit.

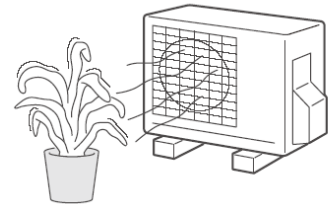

Could result in harm to animal and plant life.

Do not block the air inlet and outlet.

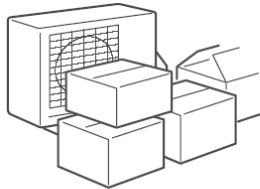

Could significantly influence performance and lead to failure.

Remove any snow from the units after snowfalls.



Snow building up around the heat pump unit and hot water storage tank unit could result in malfunction and failure.

Select an installation place with consideration given to neighbors.

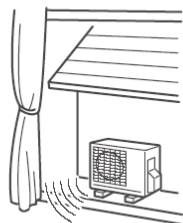

Please select a place where noise and vibration while operating will not bother your neighbours.

Check the installation conditions of the unit.

Installation of the unit in the following places could result in accidents or failure and the performance of the unit not being guaranteed.

- Anywhere the lowest temperature reached is below minus 10 degrees centigrade
- Indoors (Applies only to the heat pump unit)
- Anywhere not completely flat, unstable or where drainage is difficult
- Ensure not to put anything around the heat pump unit. Could result in poor performance and unexpected problems. In the winter in particular please pay attention to any snow coverage.



Caution

Do not use the shower or any hot water for at least one minute after recovery from a power cut.



Hot water may unexpectedly exit from the shower.

When using the emergency water cock first verify the temperature of the hot water and ensure to only use a heat-resistant vessel.



Hot water will be discharged.

- Ensure to avoid being burnt.
- Glass vessels could be broken by the heat.

In the case of any abnormality turn the earth leakage breaker to "OFF".

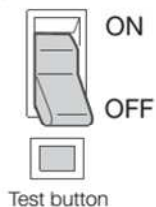

Use of the breaker in any abnormal situation could result in electric shock or fire.

- Please contact the dealer from whom you purchased the product.

Do not install the unit anywhere it will be exposed to seawater.

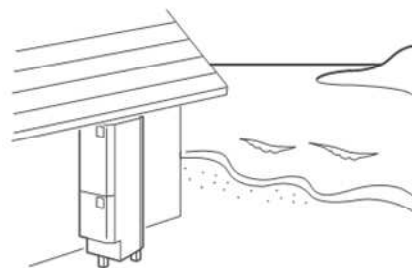

Could result in the unit malfunctioning.

Do not run the hot water directly into sink outlets etc.



Could result in being burnt or the drainage pipe being damaged by the hot water.

- Ensure to mix with cold water when running the hot water.

Installation details

This Sanden Eco Hot water Heat Pump System must be installed by a licensed person in consideration of the following standards and regulations:

- AS/NZS3500 National plumbing and drainage code hot water supply systems – acceptable solutions
- HB 263-2004 Heated water systems plumbing industry commission
- AS/NZS 3000 Electrical installations (known as the Australian/New Zealand wiring rules)
- Notice to Victorian customers from the Victorian Plumbing Industry Commission. The *Victorian Building Act 1993* requires that this Heat Pump Water Heater System must be installed by a licensed person. Only a licensed person will provide a Compliance Certificate, showing that the work complies with all the relevant standards. Only a licensed person will have insurance protecting their workmanship for six years.
- The unit has been specifically designed for domestic hot water heating and is not suitable for any other purpose.
- The unit is designed to operate when connected to the town water supply with a maximum operating pressure of **500 kPa**. To ensure the mains pressure does not exceed this, a pressure-limiting device that complies with AS1357 must be connected to the town water supply line.
- This system delivers hot water exceeding 50° C. Reference should be made to AS/NZ3500 and/or local regulations relating to the need for temperature tempering devices.
- The unit must be stored and transported in an upright position. Failure to do so may render the unit faulty. Such failure is not covered under any warranty agreements. Failure to comply with the above conditions will void the warranty.

Figure 2: Typical installation layout

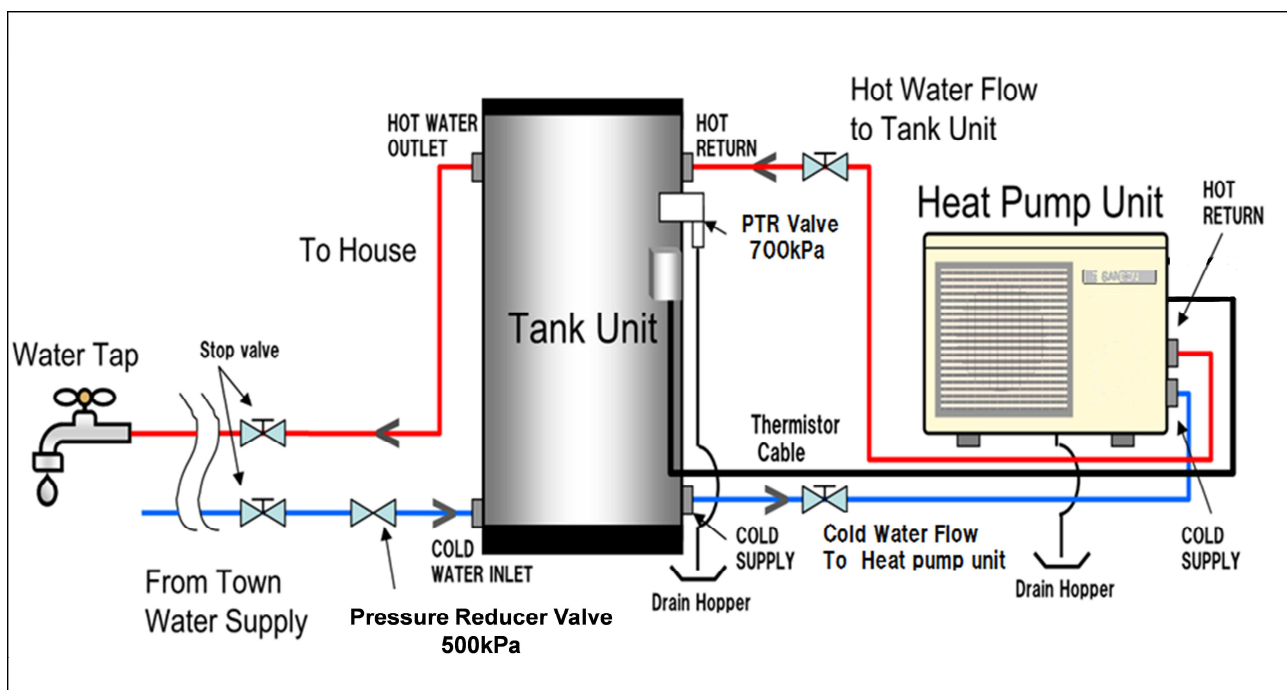

Trouble Shooting Guide

If you are faced with a problem in using our Hot Water Heat Pump system, please check the following items, before seeking professional help.

Status	Considerable Causes	Action to Take
No hot water comes out of water tap Temperature of hot water is too low	Small or no hot water is left in the storage tank.	<ul style="list-style-type: none"> - Stop using hot water and wait for about 1 hour - Consider a change of the electricity supply off-peak mode (Length of power-supply hours may be too short for the water heating cycle to cover the hot water consumption)
	Air removing procedure from the heat pump system may be insufficient.	- Open the water drain plugs on the Heat Pump Unit to remove air from water circuit. (Be careful for burning)
	Filter on cold inlet connector may be blocked.	- Check the filter and remove if there is any blockage
	Water flow speed may be dropped due to the heat pump piping bend, blockage or crush.	- Check for any piping bend or crush and remove if any
	Pipes may be frozen.	- If frozen area is found on the piping, melt the ice on the pipe and provide a heat insulation
	Stop valve is closed.	- Open the valve
	Air absorption is not sufficient due to a blockage on the evaporator.	- Remove the object blocking the air flow through the evaporator (e.g. fallen leaves, grass, snow, etc.)

For those problems not listed in the list above, an inspection provided by a skilled engineer is required. Please contact your local Dealer.

Caution:

Do not turn off the electricity supplied to the heat pump system even if you go away from home and do not use hot water for a long while.

If the system is equipped with freeze protect heaters, also do not turn off the power supply to the heaters.

Failure to do so may cause the pipes to crack, due to freezing.

Error Codes

When an error has occurred, a red LED on the operation panel turns on and an error code is displayed on the LED display. The panel does not turn to the display sleep mode while the error code is shown.

Figure 3 Error Code example



Below is the list of the error codes. If the corrective action does not solve the error problem, a malfunction of the PCB is highly likely.

Error code	Error contents	Error code	Error contents
H9	HP ambient temperature thermistor error	F5	Communication error between main PCB to control PCB
HC	HP water outlet temperature thermistor error	E8	High inlet current error
J3	HP discharge temperature thermistor error	H8	Current error
J5	HP suction temperature thermistor error	L4	High temperature of module error
J6	HP Heat exchanger temperature thermistor error	L5	High outlet current error
J8	HP water inlet temperature thermistor error	P4	Module temperature thermistor error
H7	Tank temperature thermistor error	U2	High voltage error
E6	Compressor booting error	HJ	Water circuit error
H6	Compressor revolution error	EC	High water outlet error
U0	Refrigerant leakage error	E9	Water pump error
E1	Main PCB error	E7	Fan motor locked
E2 L7	Control PCB error	F3	Discharged temperature error

Removing air from the system

Please note:

Plumbing work should only be completed by a licensed plumber

- The following steps must be taken to ensure all air is removed from the system. Incorrect removal of air may cause the water temperature to vary.
- Plumb pipes to the tank unit and the heat pump unit.
- Push up the lever on the PTR valve to open, and fill the tank unit with water.
- Confirm that the water comes out of the relief valve and then close the lever.
- Open the hot water taps in the home to remove air.
- Close the hot water taps in the home after no air is confirmed in the water.
- Open the water drain plug on the heat pump unit.
- Close the plug after no air is confirmed in the water.
- Connect the power to the heat pump unit.
- Air removing process (Refer to figure 4)
 1. Switching to Air Removing Mode
Long press the “Up” and “Down” keys to switch to the “Heat Setting Mode”.
 2. Press the “Up” or “Down” keys to switch to the “Air Removing Mode” and press the “Enter” key. Press the “Up” keys again to display “APon”, then press the “Enter” key.
It will automatically go back to the clock display mode than 5 minutes.
- Open the hot water taps in the home to remove air.
- Close the hot water taps in the home after no air is confirmed in the water.

Figure 4: Air removing process

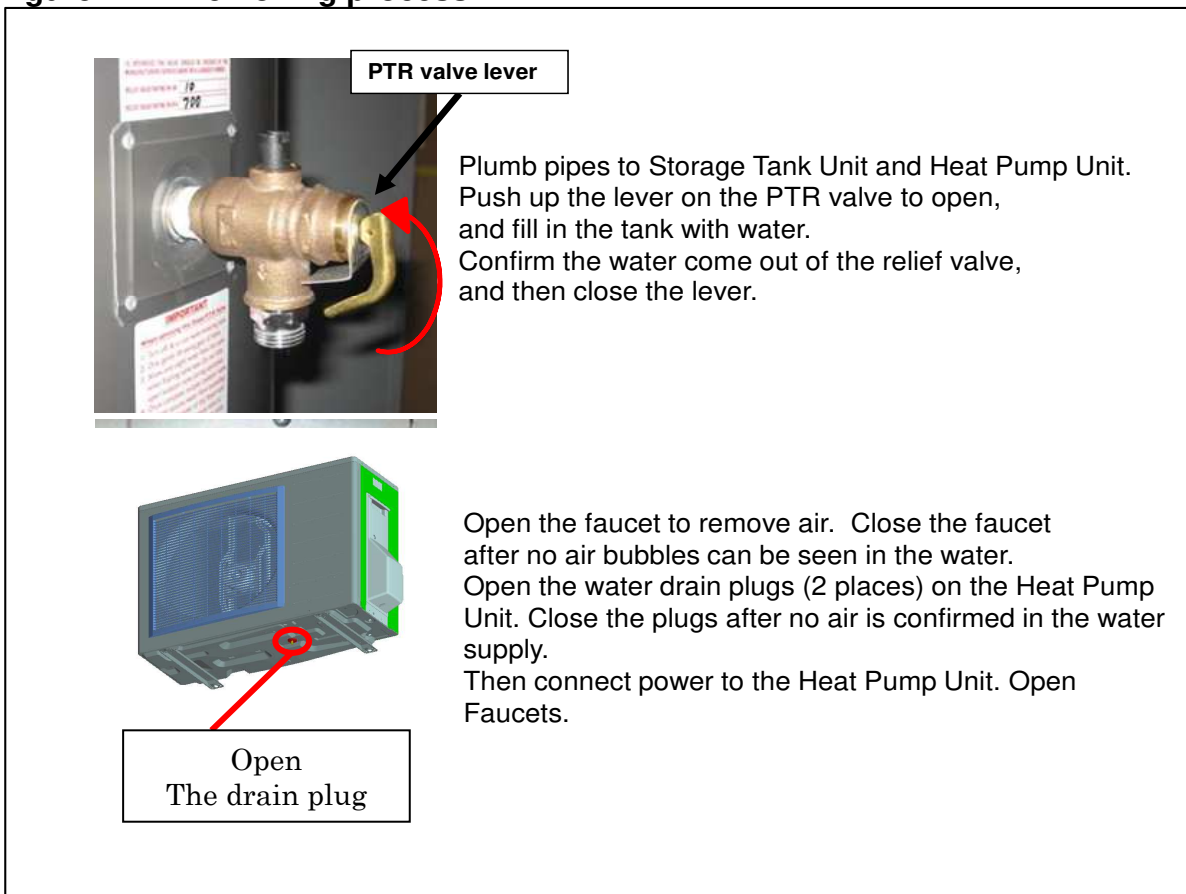

Electrical connections

- Electrical installation should be done only by a licensed electrician who carries out the work according to the relevant regulations for electrical safety and wiring.
- Follow the wiring rules for the breaker rating and the thickness of the electrical wiring.
- Verify that the tank unit is full of water and the water stop cocks are open before turning on the power.

System operation, if connected to continuous power

- The system runs its water heating cycle once a day to fill up the storage tank unit with heated water.
- If the block out time function is selected (setting is covered in page 16 of Installation Manual) the unit will not operate during the block out times – this function is typically used on installations that have time of use electricity tariffs
- The water heating cycle operation starts automatically when the residual hot water in the tank unit decreases.
- The system will not run if the electrical power supply is cut off (i.e. if it is connected to off-peak power). However, the system will automatically start operation, once the electricity becomes available.

System operation if connected to off-peak electricity

- There are no special settings for the off-peak connection. The system will run once the power becomes available and the temperature in the tank drops below the set point of the tank thermistor. If connecting the unit to off peak ensure that the off-peak tariff provides a minimum of 5 hours continuous power, as it can take at least four hours to fill the tank unit with hot water at installation. If the ambient temperature is lower than 10°C this can be longer.
- If the unit is connected to off peak power and hot water consumption has been exceptionally high, then hot water may not be available until the next power supply cycle.
- Daily frequency and amount of hot water consumption may also affect the duration of the heating cycle operation.

Select the electrical supply mode that best suits the customer's hot water consumption. The type of off-peak connection may need to be changed if hot water supply is not maintained as required.

Figure 5: Outline of electrical system connections

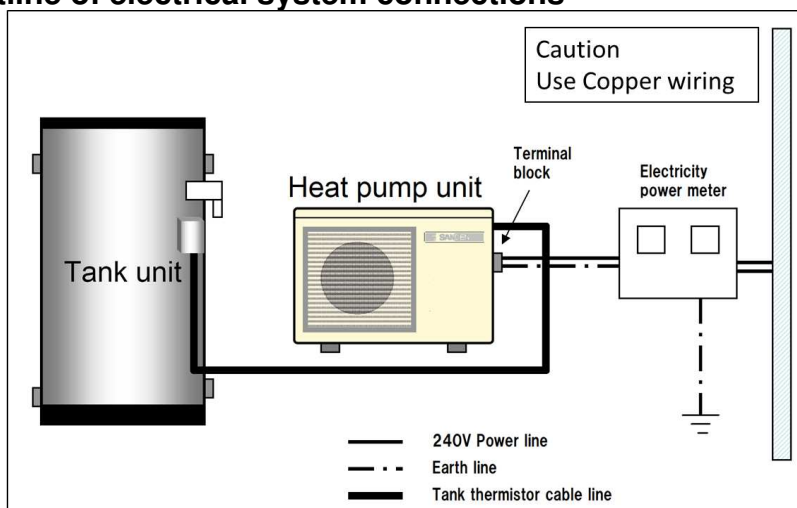

How to connect power line and thermistor cable

Please note :

Electrical installation should only be done by a licensed electrician

- Remove the piping cover screw clamp fitting.
- Connect the power supply line to the terminal block.
- Hold the power supply line below the terminal block with the screw clamp fitting.
- Connect the thermistor cable line to the terminal block.
- Hold the thermistor cable with the code clip and conduit clip
- Attach the piping cover back on the heat pump unit.

Figure 6: Connect power cables

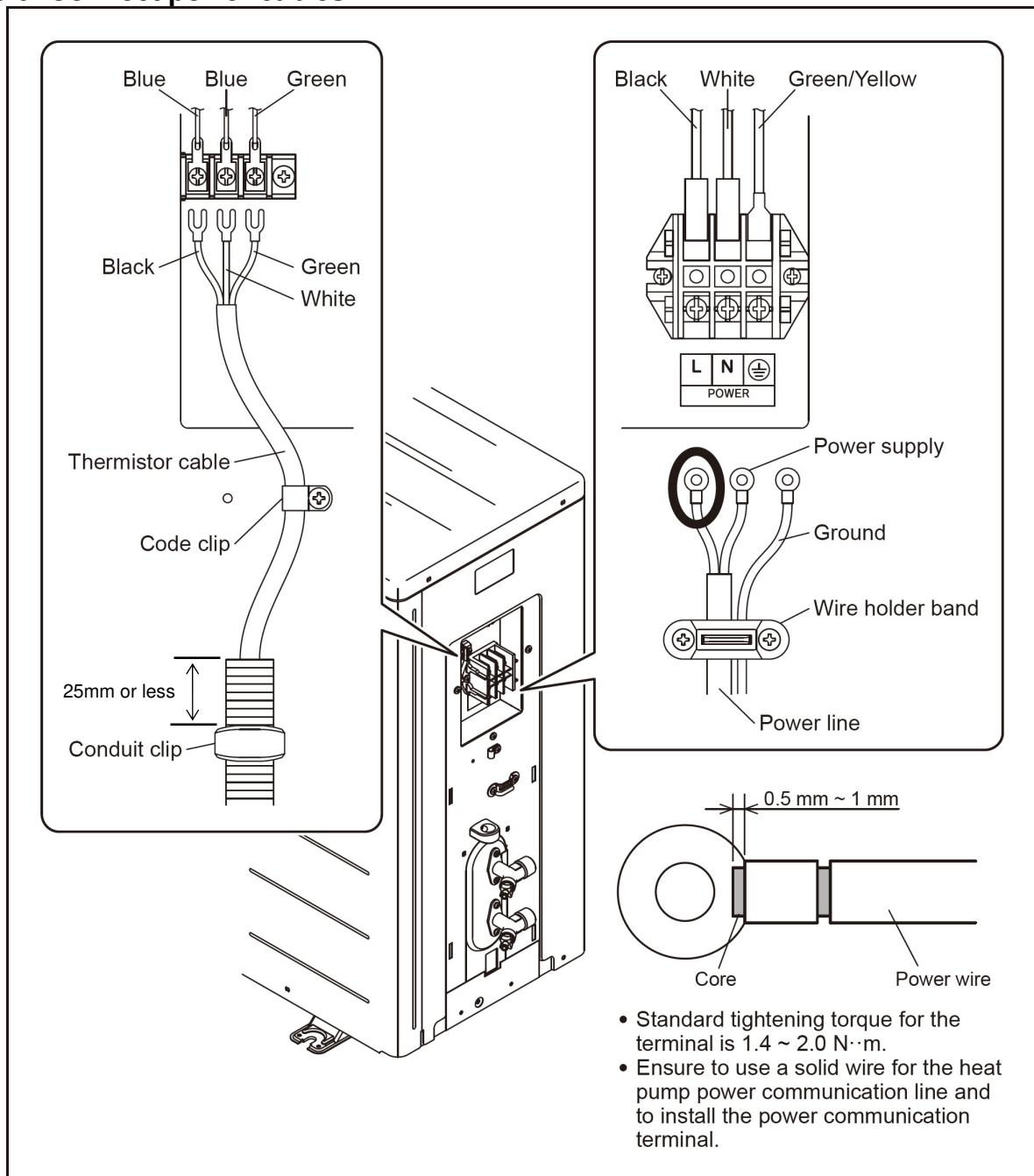

Water Supply Quality

Chloride, Water Hardness and pH

In high chloride water supply areas, the water can corrode some parts and cause them to fail. Where the chloride level exceeds 200 mg/litre or Water Hardness level exceeds 200 mg/litre warranty does not apply to the heat pump unit and tank unit. pH is a measure of whether the water is alkaline or acid. In an acidic water supply, the water can attack the parts and cause them to fail.

No warranty applies to the heat pump unit and tank unit where the pH is less than 6.5 or more than 8.5. The water supply from a rainwater tank unit in a metropolitan area is likely to be corrosive due to the dissolution of atmospheric contaminants.

Water with a pH less than 6.5 may be treated to raise the pH. It is recommended that an analysis of the water from a rainwater tank be conducted before connecting this type of water supply to the system.

Figure 7

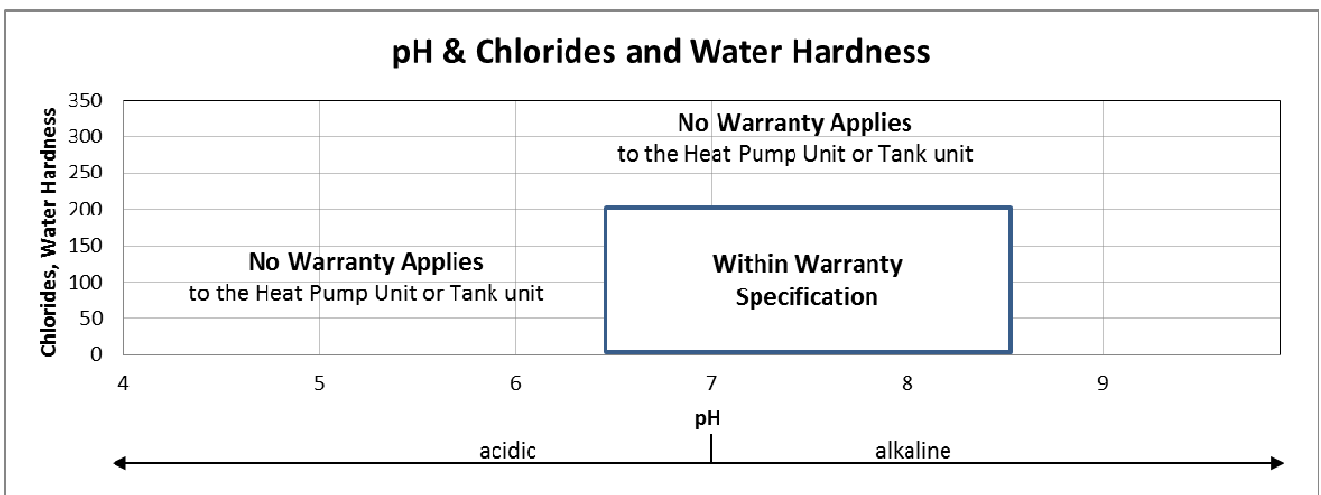

Change of water supply

Changing, or alternating, from one water supply to another can have a detrimental effect on the operation and/or life expectancy of the water tank unit cylinder, PTR valve, water heating circulation and the heat exchanger in the system. Where there is a changeover from one water supply to another, for example, a rainwater tank supply, desalinated water supply, public reticulated water supply or water brought in from another supply, then water chemistry information should be sought from the supplier or the water should be tested to ensure it meets the warranty requirements in this manual.

Technical data

Heat pump Unit Dimension

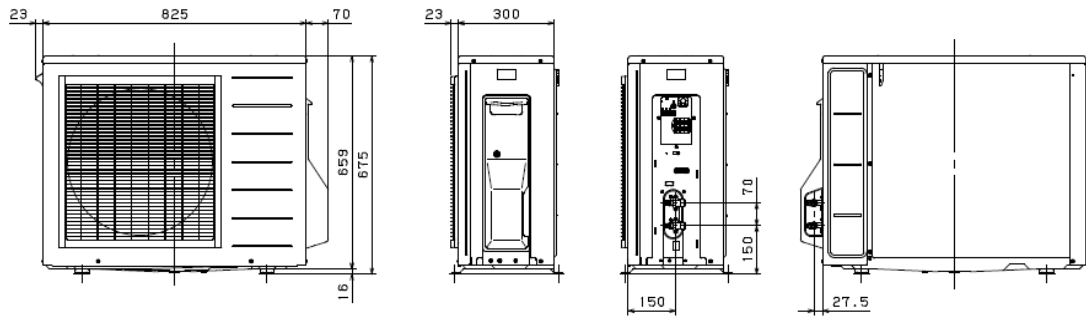
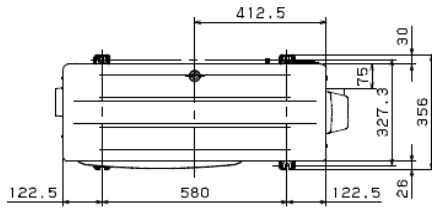

Unit: mm

Specification

Refrigerant type	R744 (CO ₂)
Mass volume	740 g
Setting Outlet water temp	63 °C
Product weight	49 kg
MAX HEAT OUTPUT	6.0 kW
MAX RATED POWER INPUT	2.3 kW
Circuit Breaker Size	20A
Design Pressure (High/Low)	14/9 MPa
Protection Raining Class	IPX4
MAX Operating water Pressure	700 kPa

Hot water storage tank unit

REFER Drawing provided with tank

Model No.	GAUS-160FQS	GAUS250FQS	GAUS-300FQS	GAUS-315FQS	GAUS-315FQV
H Height	970mm	1428mm	1891mm	1748mm	1626mm
A Hot Water Outlet & PTR Valve	753mm	1212mm	1693mm	1531mm	1432mm
C Sensor Port	249mm	708mm	1086mm	1027mm	1111mm
B Cold Water Inlet / Heat Pump Flow	223mm	222mm	208mm	221mm	115mm
D Diameter	621mm	621mm	580mm	621mm	638mm
Weight	29kg	45kg	50kg	55kg	90kg
Storage Capacity	160L	250L	300L	315L	315L
Inner Tank	Stainless Steel	Stainless Steel	Stainless Steel	Stainless Steel	Vitreous Enamel
Water Connections & Settings					
	700(kPa)	700(kPa)	700(kPa)	700(kPa)	700(kPa)
Expansion Control Valve Setting (ECV) (kPa)	600(kPa)	600(kPa)	600(kPa)	600(kPa)	600(kPa)
Maximum Mains Pressure Settings					
With ECV	500(kPa)	500(kPa)	500(kPa)	500(kPa)	500(kPa)
Inlet Water Operating Pressure	500(kPa)	500(kPa)	500(kPa)	500(kPa)	500(kPa)
Adjustable Tempering Valve	1400(kPa)	1400(kPa)	1400(kPa)	1400(kPa)	1400(kPa)
Hot and Cold Connection	Rp 20 (3/4") Female	Rp 20 (3/4") Female	Rp 20 (3/4") Female	Rp 20 (3/4") Female	Rp 20 (3/4") Female
Watermark Licence No.	WM-022333	WM-022333	WM-022333	WM-022333	WM-022333
Colour	Surfmist & Ironstone Ends	Surfmist & Ironstone Ends	Surfmist & Ironstone Ends	Surfmist & Ironstone Ends	Surfmist & Ironstone Ends
Country of Manufacture	Australia	Australia	Australia	Australia	Australia
Warranty	15 Years Prorata (Excludes WA)	15 Years Prorata (Excludes WA)	15 Years Prorata (Excludes WA)	15 Years Prorata (Excludes WA)	5 Years (WA only) 10 Years Prorata (all other states)

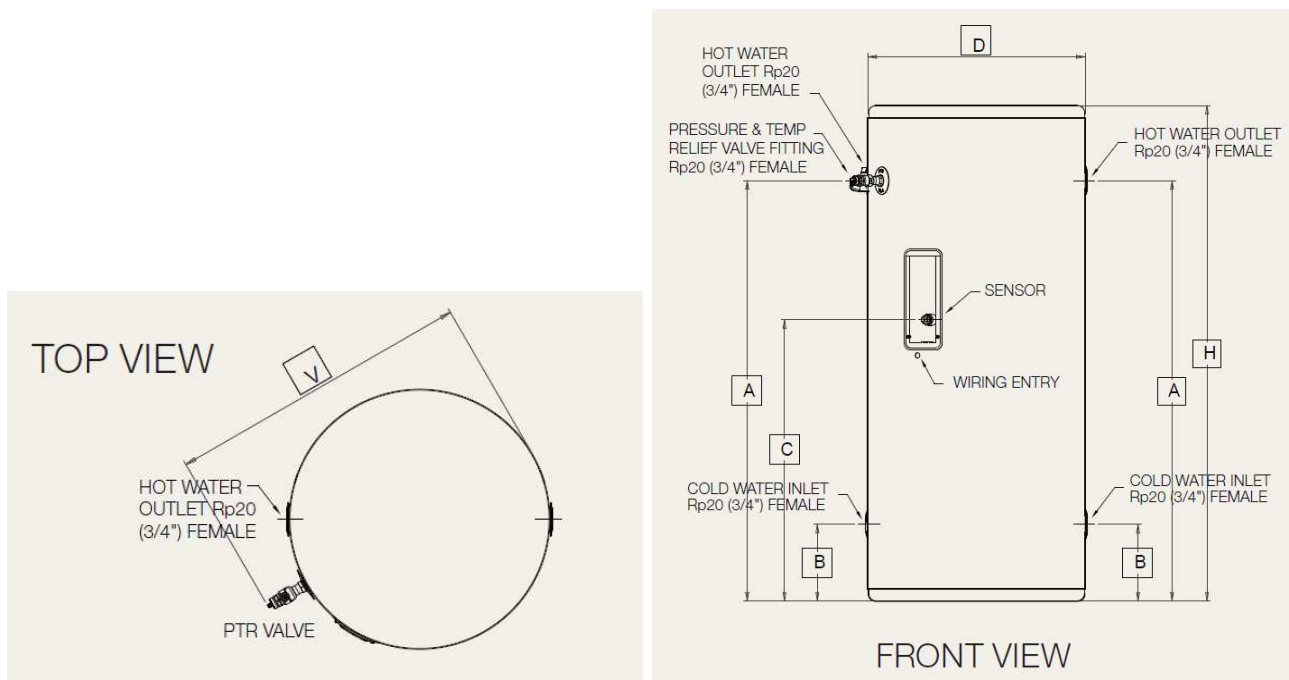



315L

300L

250L

160L

Warranty Policy

Warranty Conditions

1. The Sanden Heat Pump Water Heater System must be installed in accordance with the installation instructions supplied with the Heat Pump Water Heater System, and in accordance with all relevant statutory/local requirements of the state/province/municipality in which the water heater is installed.
2. Where a failed component or Heat Pump Water Heater System is replaced under warranty, the balance of the original warranty period will remain effective. The replaced part or Heat Pump Water Heater System does not carry a new warranty.
3. Where the Heat Pump Water Heater System is installed outside the boundaries of a metropolitan area as defined by Sanden or further than 25 kilometers from an accredited service agent, the cost of transport, insurance and travelling costs between the nearest accredited service agent's premises and the installed site shall be the owner's responsibility.
4. Where the Heat Pump Water Heater System is installed in a position that does not allow safe, ready access, the cost of accessing the site safely, including the cost of additional materials handling and/or safety equipment, shall be the owner's responsibility.
5. The warranty only applies to the Heat Pump Water Heater System and original or genuine (company) component replacement parts and therefore does not cover any plumbing or electrical parts supplied by the installer and not an integral part of the Heat Pump Water Heater System. Such parts would include pressure regulating valve, isolation valves, check valves, electrical switches, pumps or fuses.
6. The Heat Pump Water Heater System must be sized to supply the hot water demand in accordance with the guidelines in the Sanden Heat Pump Water Heater System literature.

Warranty Exclusions

1. Repair and replacement work will be carried out as set out in the Sanden Heat Pump Water Heater System warranty. However the following exclusions may void the warranty and may incur additional service charges and/or cost of parts:
2. Accidental damage to the Heat Pump Water Heater System or any component, including: Acts of God, failure due to misuse, incorrect installation, attempts to repair the water heater other than by a Sanden accredited service agent or the Sanden service department.
3. Where it is found there is nothing wrong with the Heat Pump Water Heater System; where the complaint is related to excessive discharge from the temperature and/or the pressure relief valve due to high water pressure; where there is no flow of hot water due to faulty plumbing; where water leaks are related to plumbing and not the Heat Pump Water Heater System or its components; where there is a failure of electricity or water supplies; where the supply of electricity or water does not comply with relevant codes or acts.
4. Where the Heat Pump Water Heater System or its component has failed directly or indirectly as a result of excessive water pressure.
5. Overflow vent drain has not been installed or is blocked or corroded
6. Where the Heat Pump has rusted as a result of a corrosive atmosphere;

cont.

7. Where the unit fails to operate or fails as a result of ice formation in the piping to or from the Heat Pump Water Heater System.
8. Where the Heat Pump Water Heater System is located in a position that does not comply with the Heat Pump Water Heater System installation instructions or relevant statutory requirements, causing the need for major dismantling or removal of cupboards, doors or walls, or use of special equipment to bring the Heat Pump Water Heater System to floor or ground level or to a serviceable position.
9. Repair and/or replacement of the Heat Pump Water Heater System due to scale formation in the waterways or the effects of either corrosive water or water with a high chloride or low PH level when the water heater has been connected to a scaling or corrosive water supply or a water supply with a high chloride or low PH level as outlined in the Owner's Manual and Installation Manual.
10. Warranty service is provided to the original owner of the equipment only.

Subject to any statutory provisions to the contrary, this warranty excludes any and all claims for damage to furniture, carpets, walls, foundations or any other consequential loss either directly or indirectly due to leakage from the Heat Pump Water Heater System, or due to leakage from fittings and/or pipe work of metal, plastic or other materials caused by water temperature, poor workmanship or other modes of failure.

Warranty Period

Subject to the Warranty Conditions and Exclusions stated above, your Sanden Heat Pump Water Heater System is warranted in a Residential application as follows:

Heat pump unit – Sanden warrants all parts labour on the SANDEN water heater system for a period of 6 (Six) years from date of installation.
Labour costs are paid directly to the servicing contractor per the payment cost schedule published by Sanden and revised from time to time at Sanden's requirement.

Tank unit – Sanden warrants that the tank will be free from defects for 10 years at 100% replacement, and for a further 5 years under a pro-rated scale, culminating in warranty end after Fifteen years from date of installation

In a Commercial or Industrial application the warranty period on both Heat Pump unit and Tank is reduced to 1 (One) year only with no Labour warranty.

Warranty terms and conditions are subject to change without notice. Please refer to our website www.sanden-hot-water.com.au for the latest updated Warranty information.

Registration for warranty

In order to register your system for warranty purposes, please visit our website www.sanden-hot-water.com.au, locate the Warranty Registration page and complete the details of your purchase

